

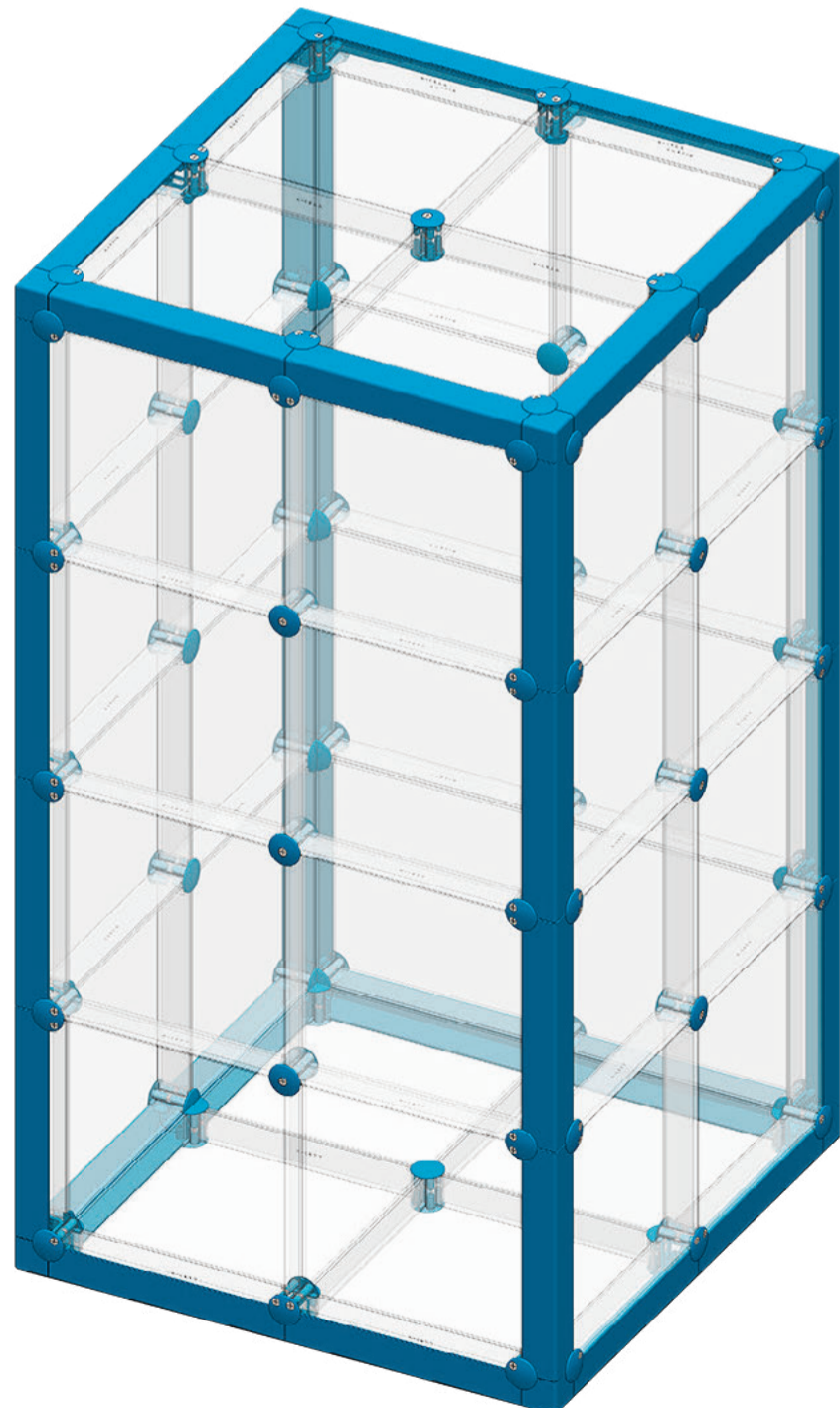

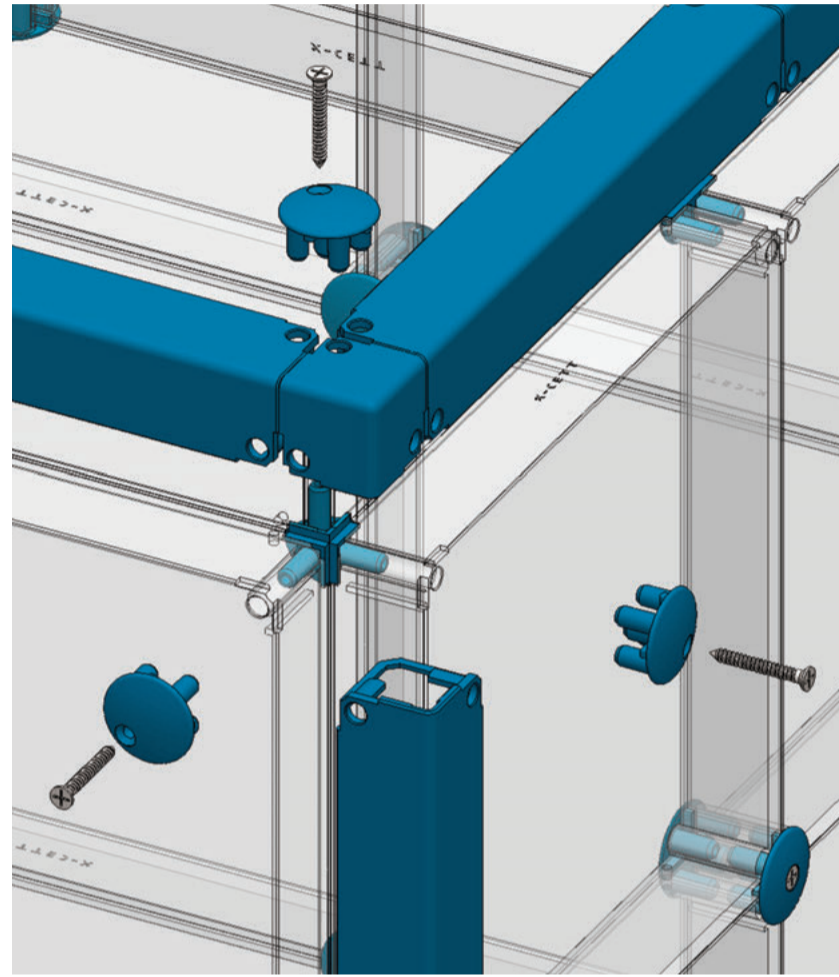

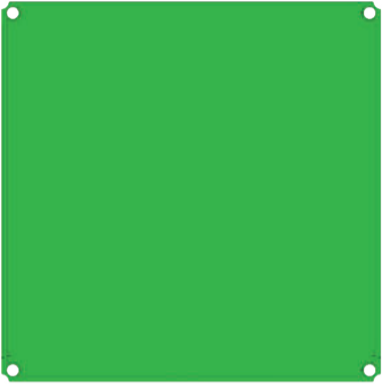

Stele 2 Lampe

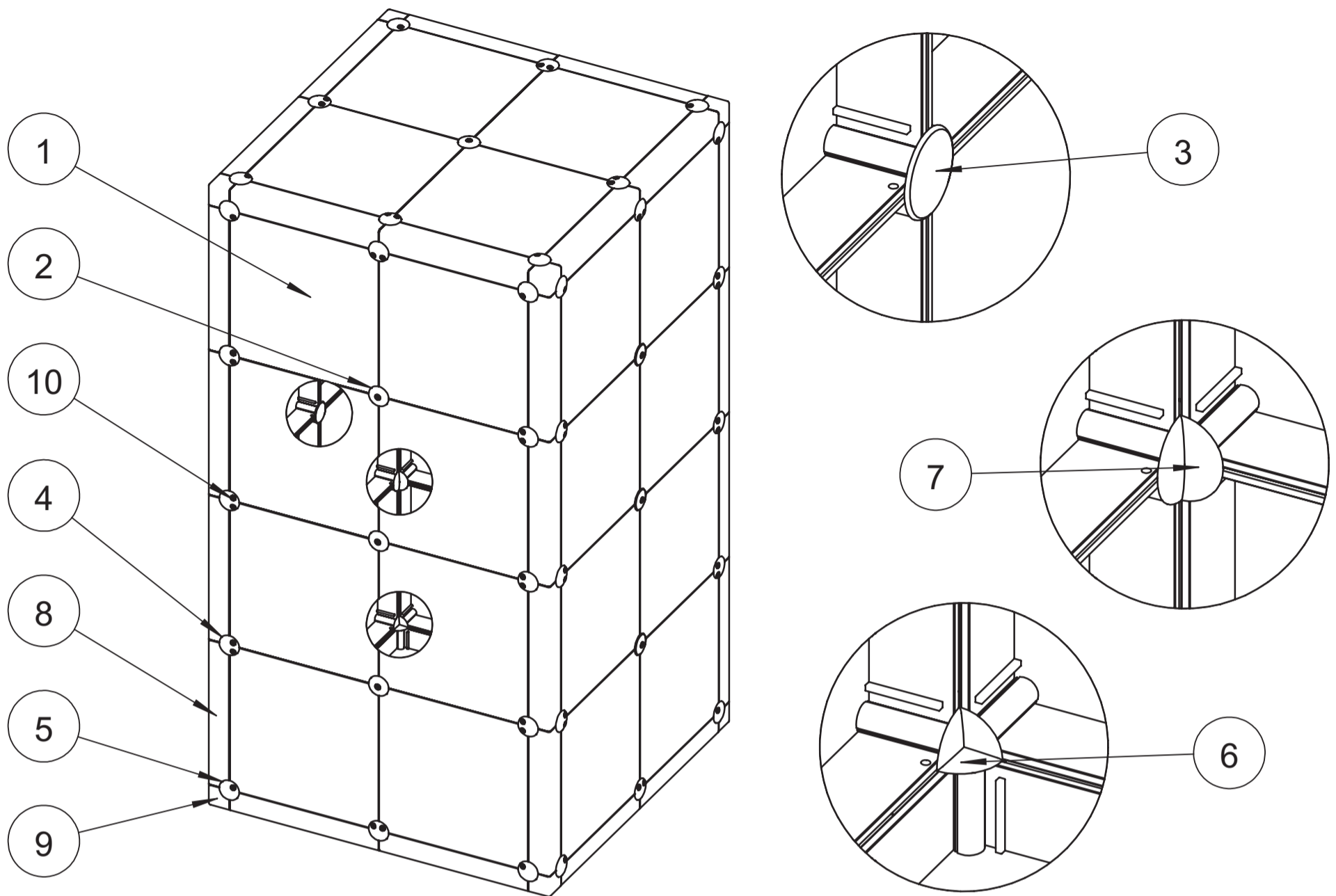
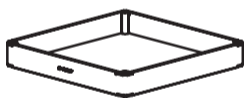
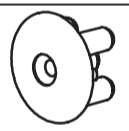
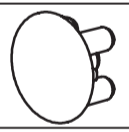

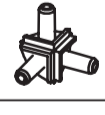
Stückliste

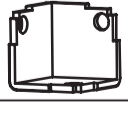

POS-NR.	BENENNUNG	Art.-Nr.	MENGE	
1	Cassette	X101.04	40	
2	Standardverbinder Senkkopf	X102.01	14	
3	Standardverbinder	X102.02	14	
4	Standardverbinder 2 Senkungen	X102.03	40	
5	Standardverbinder 1 Senkung	X102.04	24	
6	Innenverbinder 3-Fach	X102.13	8	
7	Innenverbinder 4-Fach	X102.14	20	
8	Eckschiene	X103.01	32	
9	Kofferecke	X103.02	8	
10	Schraube		118	

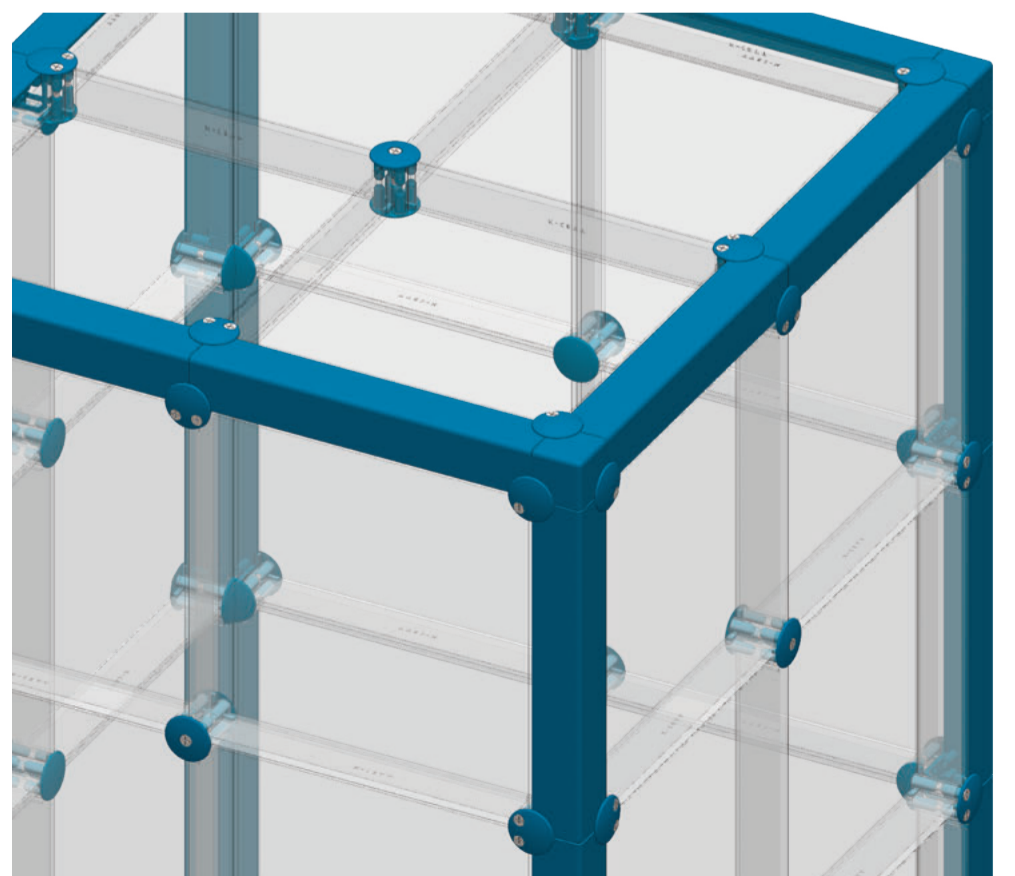
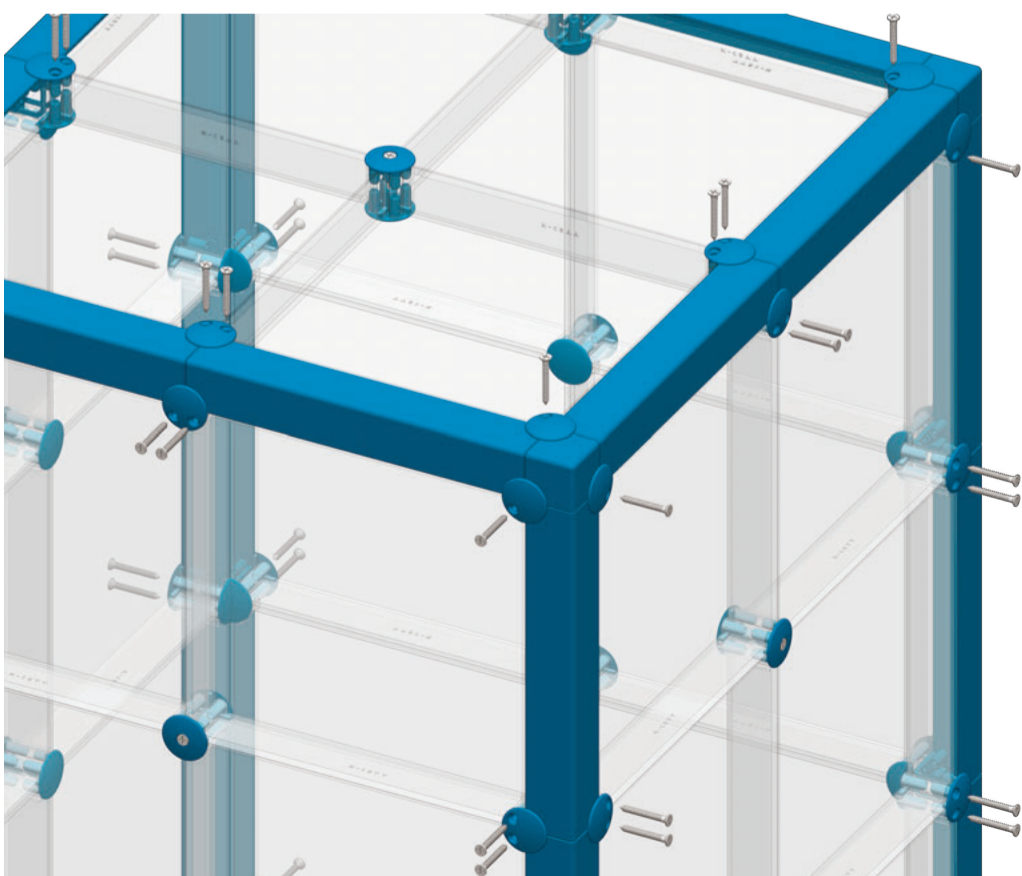
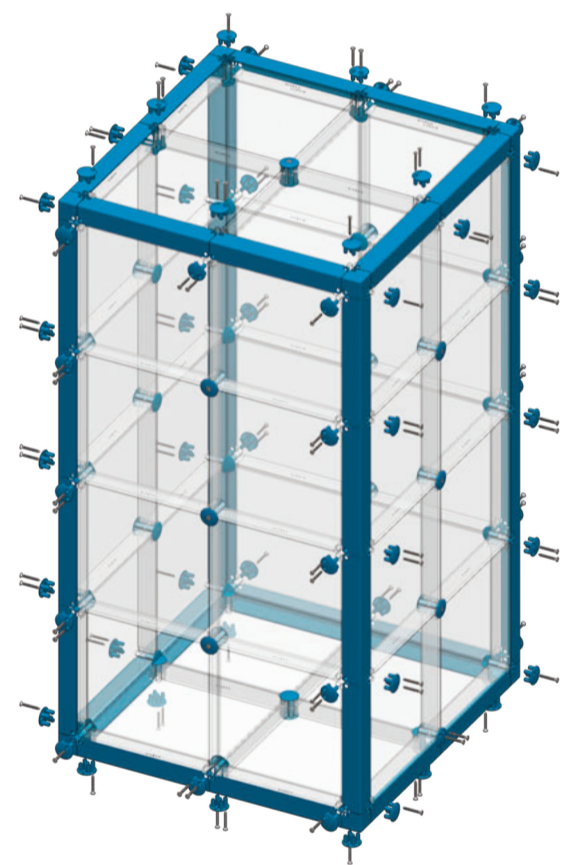
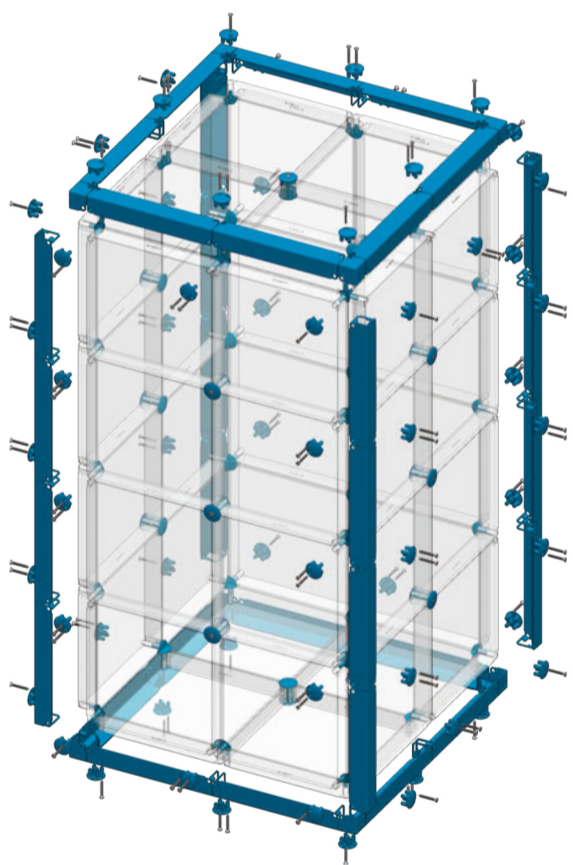
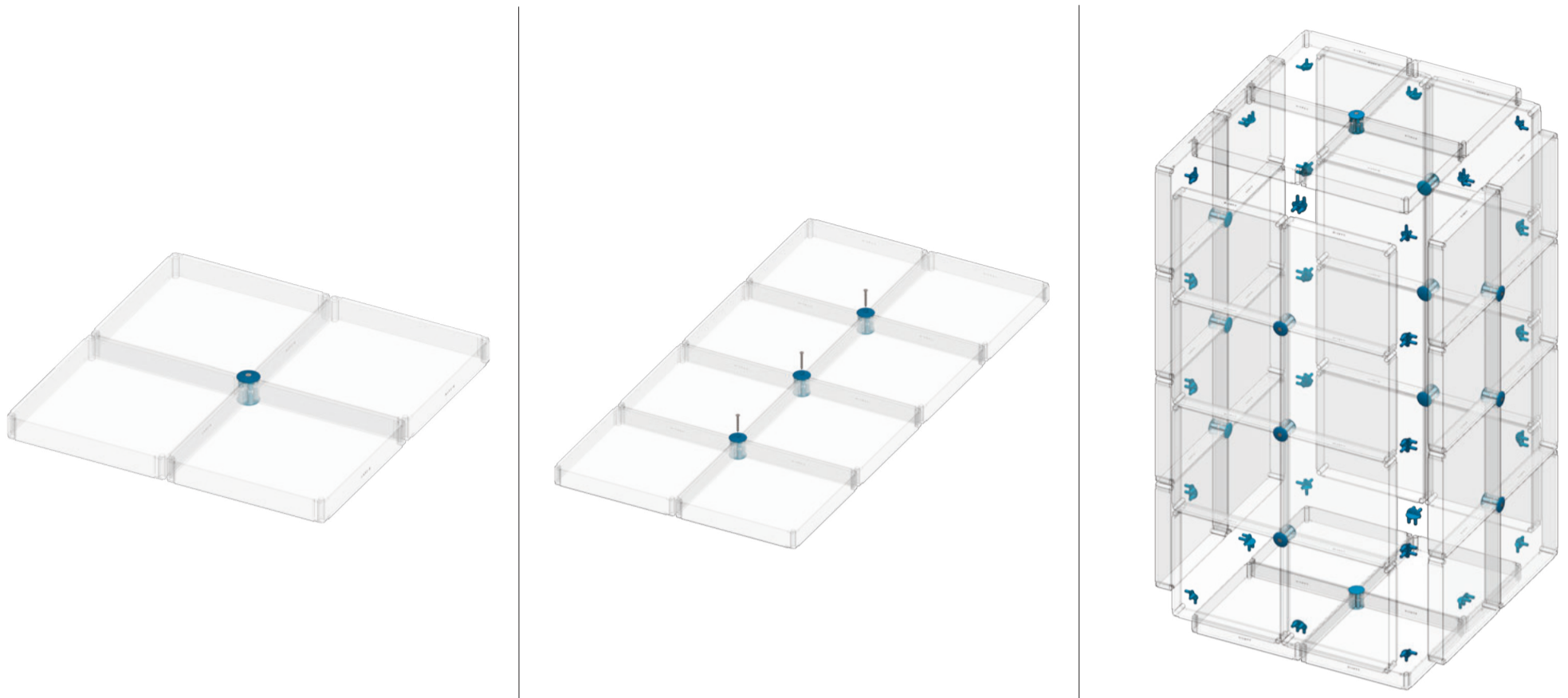

-Werkzeug
-Reinigung

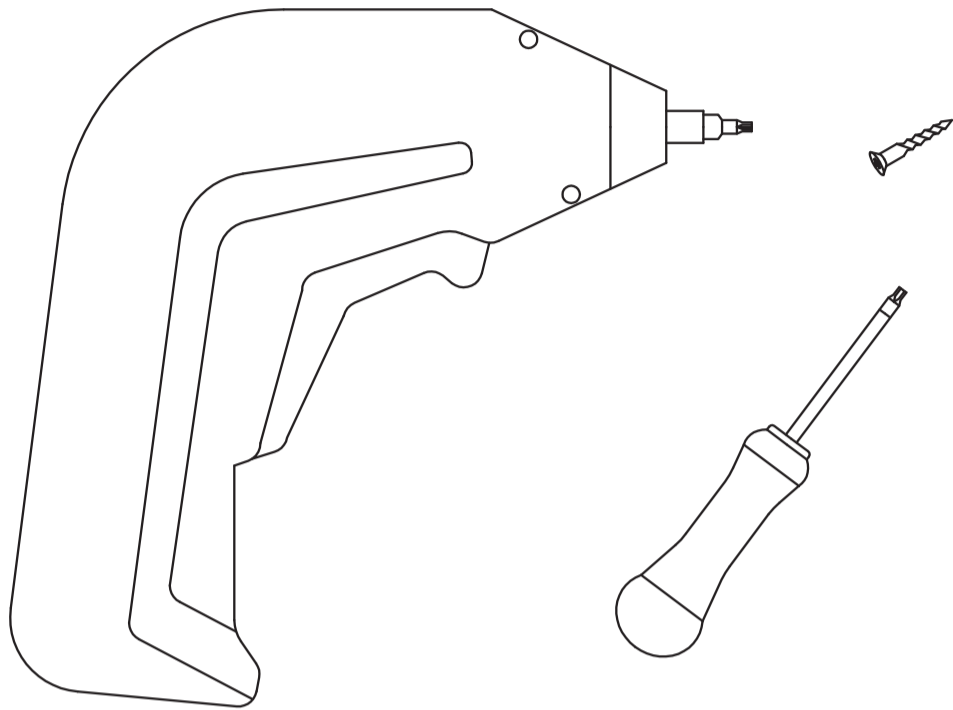

Benötigte Schrauben:
SPAX T 10 ; 3 x 25

Benötigtes Werkzeug:
Schraubendreher T 10

Maximales Drehmoment:
1 Nm

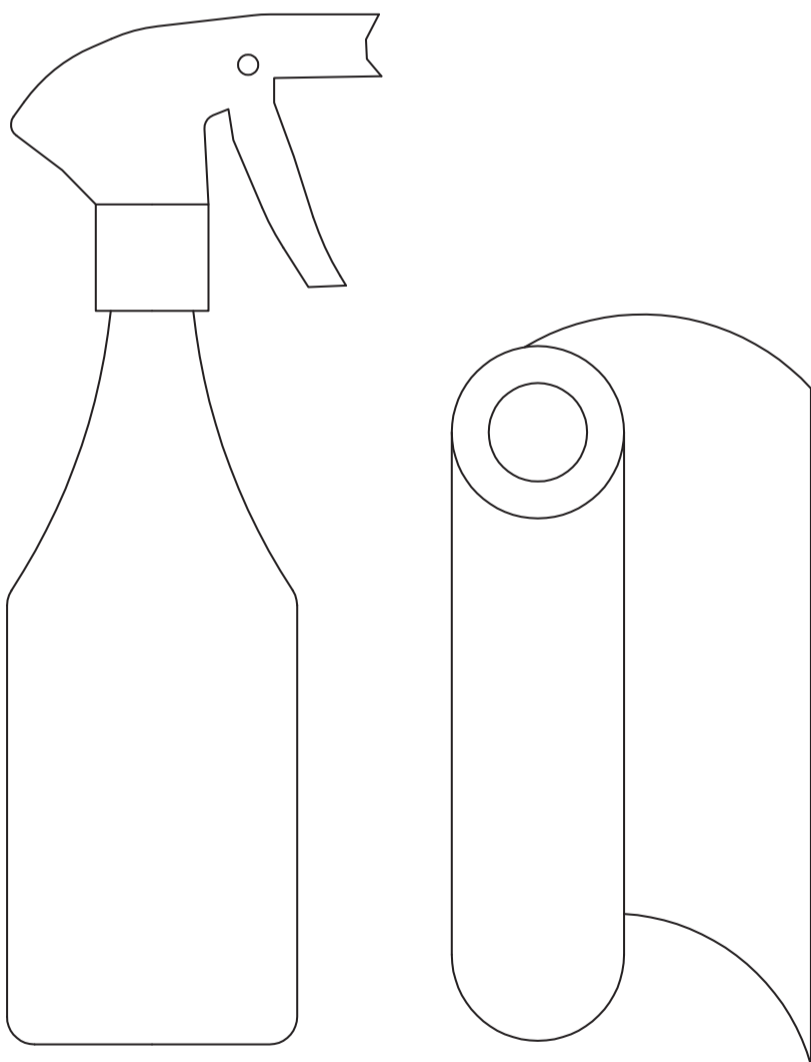

Reinigung der Systembauteile:

wie bei Autoscheinwerfern, mit
Wasser und Shampoo und einem
weichen Tuch.

xx niemals mit Lösungsmitteln xx

X-CETT Germany

Schreck Form e.K. Fon.: +49 6451 7186888 ; E-Mail: info@schreck-form.com ; www.X-Cett.com